

Article number: 201241382A

Description: E+G Retaining magnets with threaded stud GN 52.4-AN-6-M3-E
Alu, Nickel, Cobalt - 450° C, 2N

Measures

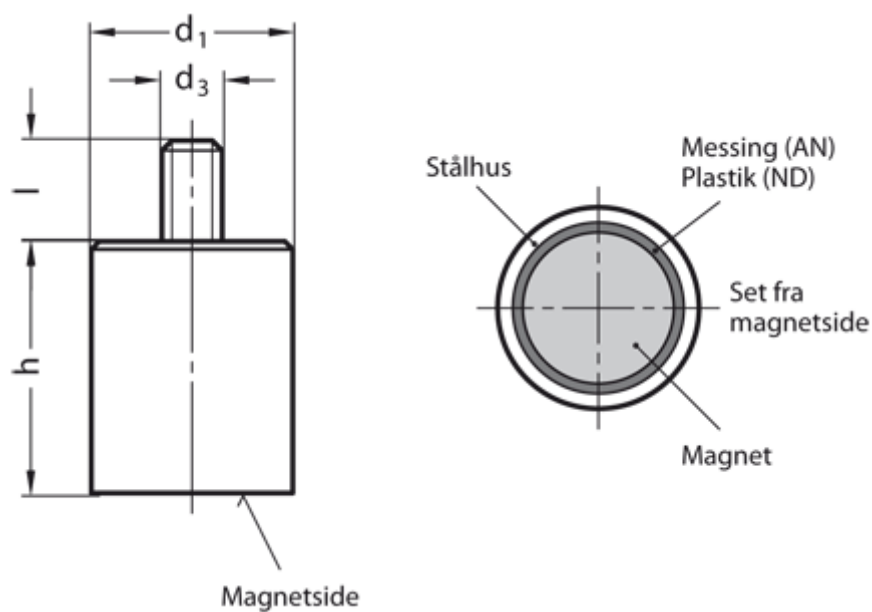

d1	= 6
d3	= M3
h	= 20 ±0,2
Holding force N	= 2.0
l	= 7
Material	= AN Alu, nickel, cobalt, 450°C